

# PRODUCT MANUAL



PRODUCT MANUAL



**NATURAL STONE SOLUTIONS**

7339 NW 66th Street - Miami, FL 33166  
Phone : 305-887-4133 · Fax: 305-574-0408

[nssusa.com](http://nssusa.com)



XINGYI POLISHING MACHINE



info@stonecrete.com  
www.stonecrete.com

Products Description

Q Series Diagram of Grinding Machine:



Q Series Gear Box Structure Chart of Grinding Machine:

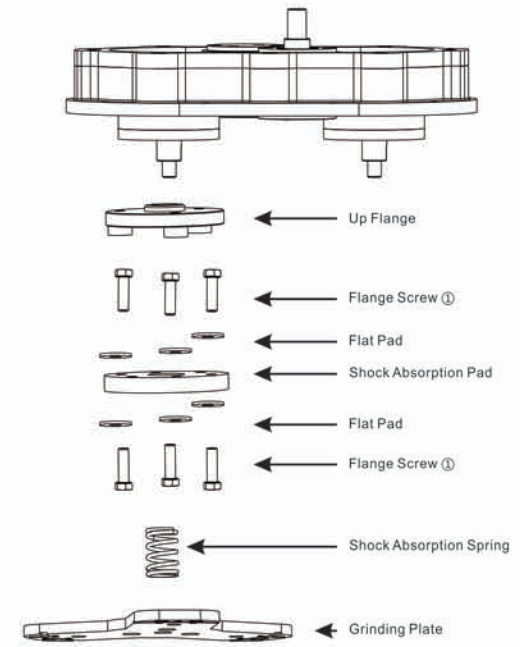

Specification:  
SC-Q2375R Floor Grinding Machine

Motor HP	7.5HP
Inverter HP	15HP
Working Width	23"
Grinding Disc	2*12" (2 Heads)
Voltage	220-240V Single Phase
Rotating Speed	300-1460rpm
Amperage	20A
Weight	408LBS
Additional Weight	No
Water Tank	8GAL
Quick Change Diamond Adapter	6

## Function Description



①. Ergonomical folding handgrip can change the height for two levels.



②. Cooperate with carrying poles for convenient transportation



③. LED lighting function



④. Big capacity water tank



⑤. Plug-in USB port



⑥. Wire rack

## Standard accessories



Rubber Skire

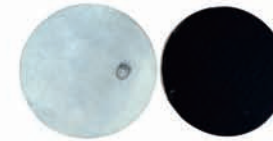

3" adapters



Wire rack



Carrying Pole



Oil Tester



LED Light



USB



Multi-function plate

## Wear parts



Start switch



Speed controller



Rubber pads



Rubber Skire

## Safety Guide

This manual is important for machine use and safety operation at first time. Non-standard operation without authorization or any modification, maintenance may cause losses or machine problem and it is dangerous. You are allow to operate the machine after trained. All maintenance must be done by qualified professional technician. Any replace parts must be provide by NSS.

- 1.Red and totally understand the safety guide.Different models,accessories,operation are different.
- 2.People who's poor physical state or without training is not allow to operate the machine.
- 3.One operator,one machine,Attention,children and irrelevant personnel are not allow to close the machine while working.
- 4.The splash guard shall be always with machine considering operator and relevant staff safety.The machine must install with vacuum cleaner while dry grinding.
- 5.This machine is only used for floor surface grinding and polishing.
- 6.Please don't start the machine when control panel shows "operation mode" or grinding plate do not touch the ground.
- 7.The machine adjusting bar have locking function in different position which ocation are show by picture in this manual.
- 8.Make sure the machine stopped running and emergency stop button was ocked, when changing abrasives or accessories.should it be necessary,pull out the power or plug.
- 9.Please do not loan the machine without instruction manual.
- 10.The necessary working dress of operator is protective helmet and shoes, headphones protection,goggles,masks.
- 11.Any item must keep away machine moving parts,like body or opening clothes.
- 12.Random modification is not allow.NSS accessories is the best choice for maintain.
- 13.Do not operate the machine in the rain or foggy day.
- 14.When the machine is operating,there shall be no explosion and steam items. Any fuel, grains,solvent,thinner or inflammable good shall be keep away the working site.



## Electrical Safety:

- 1.All electrical maintenance allow only operate by professional technician.
- 2.Note: the machine after stop, the line is still electricity. Cut off all the power supply before maintenance machine.
- 3.Do not operate the machine,when distribution box is opening.
- 4.The machine is equipped with overload protection device and will automatically jump out when machine is overload ban machine (in the case of safety to adjust the overload).
- 5.Under the condition of overload continuous use machine, thereby causing loss to the other and machine can't normal work, not give warranty.
- 6.The machine equipped with frequency converter designed to speed and protect the safety of the user and machine.It is forbidden to change, adjust the frequency converter and without the consent of the NSS department modify inverter parameters.If the device fails, can only use standard provided by the NSS to replace damaged parts. (due to changes, adjust the frequency converter, and without the consent of the NSS technology change frequency converter parameters, thereby causing loss to the other and machine can't normal work, not give warranty.)
- 7.Absolutely not modified converter internal parts or on its own line.
- 8.The machine such as overload current, must pay special attention to.
- 9.Wire or live wire load load, do not take out stitches.
- 10.The use of the damaged power cord may result in electric shock.Do not use the damaged power cord.
- 11.The wire surface should be far away from high temperature.
- 12.It should keep electric equipment of the machine dry, and machine should be stored in a dry place.
- 13.When the power is cut off, the panel light before go out, said there are still high pressure frequency converter internal.Is very dangerous, do not touch insulate electrical equipment parts.
- 14.Machine motor, electric cabinet ban water (due to the water, thereby causing loss to the other and machine doesn't work, not give warranty).
- 15.**Please don't open or disconnect any part of NSS without NSS authorization or guide, or else , we can't guarantee it.**

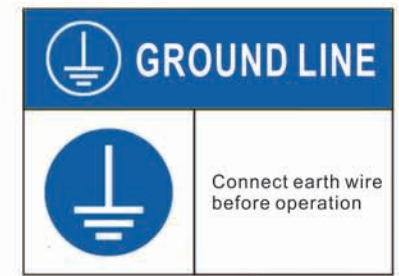

## Operation Guide:

- 1.Operator's safety suit : working shoes, helmet, sound insulation earmuff, goggle, dust mask.
- 2.Make sure there is no oil leakage, electric leakage, water leakage on the machine before using.
- 3.Check the machine control switches and electric parts are in good conditions.
- 4.Before operation, check the working surface and remove any protrusion to prevent machine plate and pads from damage .
- 5.Make sure no obstacle or human people at working area .
- 6.Make sure there have enough lighting device .
- 7.Double check before plug in the machine voltage ,HZ is strictly conform to input voltage and HZ and no lack of phase .(No guarantee if the machine can't work due to the input voltage and machine voltage are different )
- 8.Connection with suitable power plug, power line just can use corresponding models as wire standard sheet,length shall not beyond 50m.
- 9.there is no available power if distance within 50 meters,please ask professional person install available outlet to the scope of work. Wire (bigger one level than above) maximum length to up to 100 meters.
- 10.Connecting with vacuum to achieve dust free working condition.
- 11.Stay away from water or dangerous cargos to prevent personal injury, machine and property loss .
- 12.Make sure the operating machine is on level.
- 13.Tight-hold hand grip ,clockwise rotate the emergency switch ,then turn on the power button and start the machine .
- 14.If machine display screen shows " OL2"hint something wrong with machine.
- 15.Don't adjust handle bar while machine is on working condition ,only allow if press on emergency switch .
- 16.Adjust axle to right place if machine always towards to one direction .(up and down adjustment)to make sure axle parallel to surface .
- 17.Pad change : adjust and hold the handle bar ,step on the pedal bracket .tilting the machine back on the ground .
- 18.Install suitable abrasives to prevent human from injury .
- 19.Pull down the plate on the ground after pads installation ,adjust the handle bar to suitable place .
- 20.Stop machine and check the pads abrasion after testing several minutes. this step is to make sure to choose right abrasives and save cost.

## How to install additional weight

Additional weight will improve the efficient when machine working.



- ①. Lift the additional weight by the hole of additional weight.



- ②. Move the additional weight to the right position.



- ③. And then lightly pushing it down,check whether the additional weight has been stable placed on the rack.

## How to use wire rack



- ①. Release wire rack.



- ②. Adjustment the suitable height and angle, Locking the rack.



- ③. Put the wire on wire rack.



- ④. Then connect the power.

Handle Position Illustrations:

Operation mode

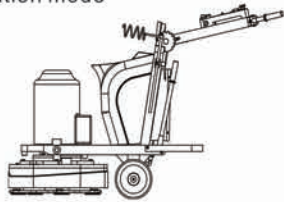

Change abrasive state preparation mode

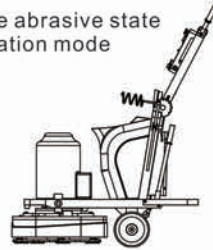

Change abrasive state

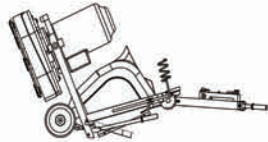

Transportation mode

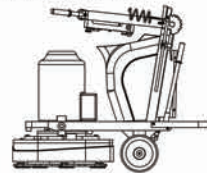

Machine Daily Maintenance Guide

Daily Maintenance:

1. Clean up the machine after each day working, especially for the attachments of grinding plate and waterproof, which will greatly increase the working efficiency
2. Clean up the water tank every 5-7 days to avoid the water strainer blocked by sediment.
3. Check the machine after finishing each project. (Besides daily maintenance, you should tighten all the connecting screws and make sure the screws of rubber pads are not loose.)
4. Using the oil rod supported by XY to measure the amount of gear oil every one week. The amount of oil should be higher than the scale 5 on the rod position. If not, pls add more until the amount of oil reaching to 5 scale.
5. If dry polishing is mostly adopted, clean up the dust on the cooling fan of inverter after every one month. Clean up the power case, banning the use of any tool to cleaning by wet, it is recommended to use high pressure dry air cleaning (gun)
6. Replace the gear oil regularly 3 months for a new machine and then one year after That.
7. Clean relief hole inside regularly.

Machine Oil Capacity Change Sheet

Model	Oil capacity/time	Unit	Mark
SC-Q204R	1.0-1.5	L	<p>WARNING: Gear oil should be changed in time as per period and volume mentioned caused by oil problem, VOIDS THE WARRANTY. During operation, when abnormal noise, oil leakage happen to gearbox, stop immediately and contact factory to know the solutions. Continuing to use the machine when gearbox abnormal, VOIDS THE WARRANTY.</p>
SC-2375R	2.0-2.5	L	
SC-Q2275R	3.5-4.0	L	
SC-Q2310R	3.5-4.0	L	
SC-Q3020P	6.0-6.5	L	
SC-Q2415R	5.0-5.5	L	
SC-Q2720R	6.0-6.5	L	
SC-Q2510P	5.0-5.5	L	
SC-Q3520P	6.0-6.5	L	

Wire Standard Sheet

Motor ( KW )	PhaseVoltage	Wire Model
2.2KW	1P 220V	3X2.5mm <sup>2</sup>
3KW	1P 220V	3X2.5mm <sup>2</sup>
4KW	1P 220V	3X4mm <sup>2</sup>
	3P 220V	3X2.5mm <sup>2</sup> +1X1.5mm <sup>2</sup>
	3P 380V	3X2.5mm <sup>2</sup> +1X1.5mm <sup>2</sup>
5.5KW	1P 220V	3X6mm <sup>2</sup>
	3P 220V	3X4mm <sup>2</sup> +1X2.5mm <sup>2</sup>
	3P 380V	3X4mm <sup>2</sup> +1X2.5mm <sup>2</sup>
7.5KW	1P 220V	3X6mm <sup>2</sup>
	3P 220V	3X6mm <sup>2</sup> +1X4mm <sup>2</sup>
	3P 380V	3X6mm <sup>2</sup> +1X4mm <sup>2</sup>
11KW	1P 220V	3X10mm <sup>2</sup>
	3P 220V	3X10mm <sup>2</sup> +1X6mm <sup>2</sup>
	3P 380V	3X6mm <sup>2</sup> +1X4mm <sup>2</sup>
15KW	3P 220V	3X10mm <sup>2</sup> +1X6mm <sup>2</sup>
	3P 380V	3X10mm <sup>2</sup> +1X6mm <sup>2</sup>

## Method of Change Gear Oil

1. Make sure the machine has been disconnected with power.
2. Place the machine to change the abrasive tool, determine the machine is stationary.
3. Firstly Use the outside the hexagon screwdriver 19th open relief device (As follow picture 1 2).
4. Remove the oil filler screw, then remove the screws of the oil port (As follow picture 1 2).
5. After without waste lubricating oil outflow, locked the screws of the oil port.
6. Put machine return to the operational position.
7. Add 6L 150 # gear oil (1.6 su gal).
8. After refueling is completed, locked the pressure relief device.



picture 1



picture 2



picture 3



picture 4



picture 5



picture 6



picture 7

## Electrical Schematics of Motor And Inverter

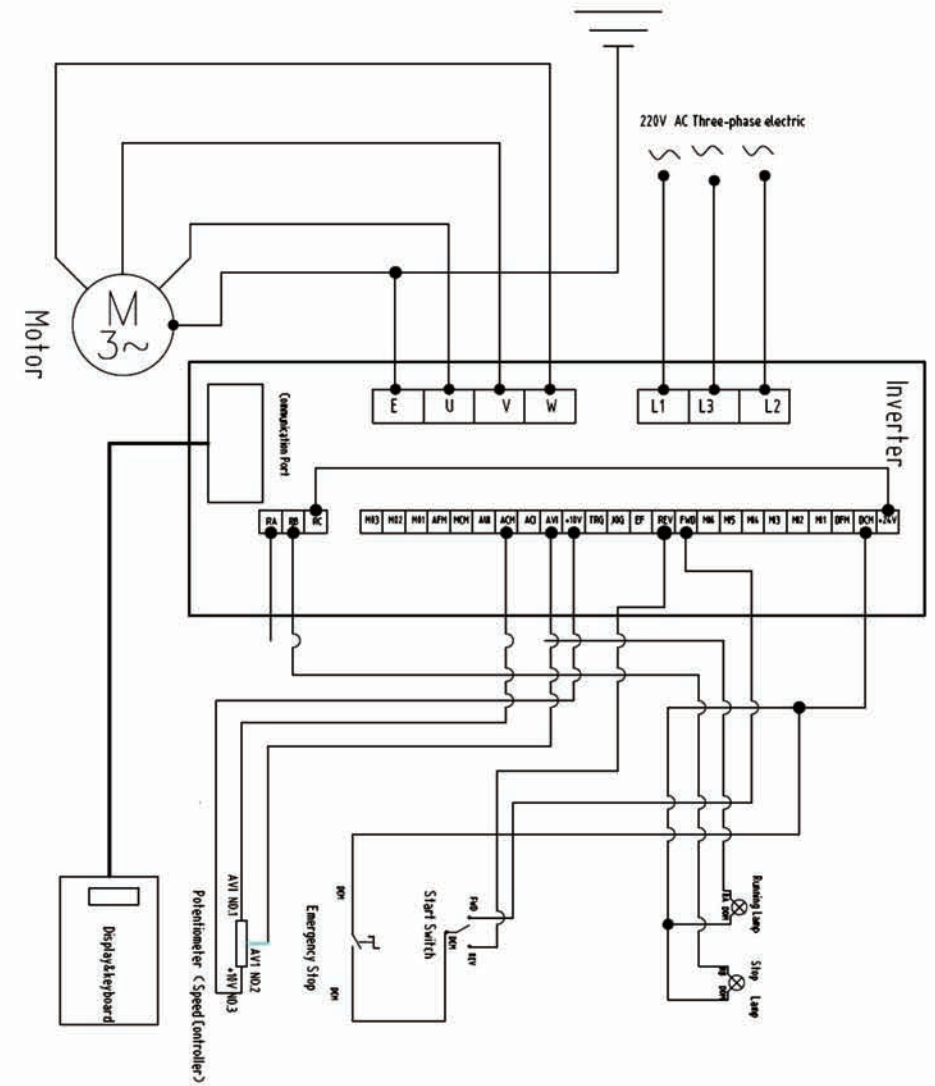

(Delta B)

Circuit Schematics of LED and USB:

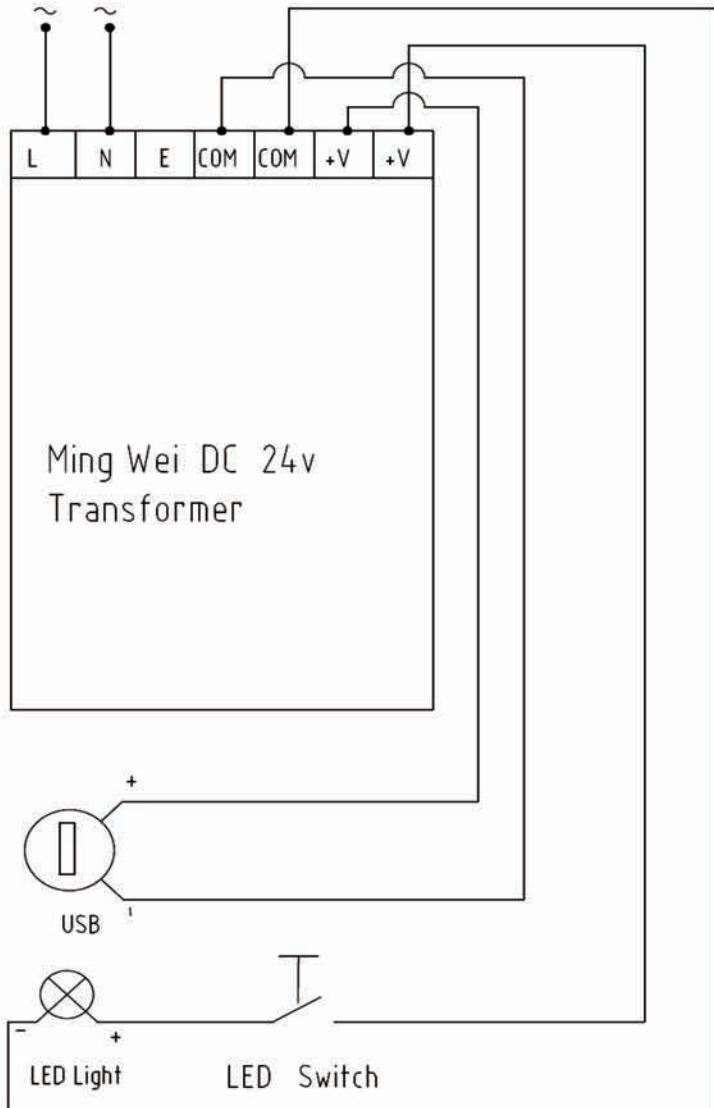



Machine Simple Trouble Shooting

The Fault Code of X Series Inverter As Follow:

Fault code	Possible fault reason	Troubleshooting
E.LU2	Voltage lack during operation The supply voltage is too low; The capacity of power system is not big enough; or there is a big impulse current in the power system. The inner dc main contactor of the AC drive is not well connected.	Check power source input; Improve power supply system; Seek help from the factory.
E.oL1	Motor overload The improper of V/F curve or the torque speed is too high; The network voltage is too low; The improper number setted of Overload on motor; The motor is in low speed for a long time.	Reset V/F curve or the torque speed. Check power source input; Reset parameter of [F5.06/18]; Choose the right capacity motor; Adopt the special purpose motor if require long-term low speed operation.
E.oL2	AC drive overload Overload on AC drive; Acceleration time is too short; Activate the rotating motor; The improper of V/F curve or the torque speed is too high.	Choose the right capacity AC drive; Extend the acceleration time appropriately. Restart the motor while it totally stop or set [F1.00] in 1 or 2. Reset V/F curve or the torque speed.
E.S.C	System Exception Acceleration time is too short; The AC drive output is interphase or short-circuit. The module is broken. The electromagnetic interference.	Increase the acceleration time; Check out the peripheral equipment and reset it after debugging. Seek help from the factory. Check out the wiring, grounding, shielding of the system and set it as requested.
E.oH2	The AC drive temperature sensor detects excessive heat. The temperature is too high; The ventilation holes are obstructed. The plug-in of the fan is loose. The fan is damaged. The electric circuit breaks down.	Ensure that the ambient temperature falls within the specified temperature range. Make sure that the ventilation holes are not obstructed. Check and reconnect the fan. Replace the same model fan. Seek help from the factory.
E.iLF	Phase Loss AC drive input phase loss	Check power source input
E.oLF	Phase Loss AC drive input phase loss	Check power source output
E.EF	External fault External devices protection	Check the external devices



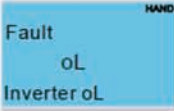
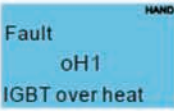



The Fault Code of Inverter of C2000(Q Series 380V)

Fault code	Display symbols	Possible fault reason	Troubleshooting
LVA		Inverter's Inner current at high Voltage is too low	<ol style="list-style-type: none"> <li>1. Check whether the input power is accordance with plug label on machine</li> <li>2. Check whether the input Voltage has the the default phase or not</li> <li>3. Check whether the motor has suddenly overload or not.</li> </ol>
OL		Output current of Inverter	<ol style="list-style-type: none"> <li>1. Check whether the input voltage has reached the machine normal working value.</li> <li>2. Check whether there are additional weight or not, if does, please remove it.</li> <li>3. Check whether the motor is overload.</li> </ol>
Oh1		Inverter inner overheat	<ol style="list-style-type: none"> <li>1. Check whether the input Voltage has reached the machine normal working value.</li> <li>2. Check whether there are the additional weight or not, if does, please remove it.</li> <li>3. Check whether the motor is overload.</li> </ol>
OrP		Default phase on input power	<ol style="list-style-type: none"> <li>1. Check whether there is default phase on input power.</li> <li>2. Check whether wire connecting between inverter and power line has loosen or not.</li> </ol>

If the above fault code appeared, all the wire checking should be operated by professional people and only can check and maintain after cut off the power line and machine. Anything happened, do not deal with by yourself. Please contact the dealer whom you purchased in time.

The Fault Code of Inverter of VFD-B(Q Series 220V)

Fault code	Display symbols	Possible fault reason	Troubleshooting
LV		Inverter's Inner current at high Voltage is too low	<ol style="list-style-type: none"> <li>1. Check whether the input power is accordance with plug label on machine</li> <li>2. Check whether the input Voltage has the the default phase or not</li> <li>3. Check whether the motor has suddenly overload or not.</li> </ol>
OL		Output current of Inverter	<ol style="list-style-type: none"> <li>1. Check whether the input voltage has reached the machine normal working value.</li> <li>2. Check whether there are additional weight or not, if does, please remove it.</li> <li>3. Check whether the motor is overload.</li> </ol>
OL1		Inverter inner overheat	<ol style="list-style-type: none"> <li>1. Check whether the input Voltage has reached the machine normal working value.</li> <li>2. Check whether there are the additional weight or not, if does, please remove it.</li> <li>3. Check whether the motor is overload.</li> </ol>
OL2		Motor overload	<ol style="list-style-type: none"> <li>1. Check whether the wire connecting between motor and inverter is loosen or not.</li> <li>2. Check whether the input Voltage has reached the machine normal working value</li> <li>3. Check whether there are the additional weight or not, if does, please remove it.</li> <li>4. Check whether the motor is overload or not.</li> </ol>
PHL		Default phase on input power	<ol style="list-style-type: none"> <li>1. Check whether there is default phase on input power.</li> <li>2. Check whether wire connecting between inverter and power line has loosen or not.</li> </ol>

If the above fault code appeared, all the wire checking should be operated by professional people and only can check and maintain after cut off the power line and machine. Anything happened, do not deal with by yourself. Please contact the dealer whom you purchased in time.

Problem	Possible Cause	Action
Machine can not run	Input wire damage	Check input wiring to make sure no damage
	Wrong input voltage	Check if voltage correct, or phase failure
	Wrong wire connection between motor and inverter	Check if wire loosen between motor and inverter
	Machine start button no working	Replace it
	Inverter problem	Repair or replace it
	Motor probelm	Repair or replace it
Machine shake violently	Grinding plates not on the same surface	Adjust the bolts and screws on grinding plates to ensure the levelness
	Different specification of abrasives	Change to same height and size of abrasives
	Aging rubber cushion	Replace with new rubbers
	Bolts loosen between gearbox and machine frame	Tighten locking screws
Abnormal Noise	Plates collision	Replace new grinding plates and then tighten the locking screws
	Bearing or transmission shaft broken	Replace them
Oil leakage at plates rotation axis	Bearing damage inside gearbox	Replace it
	Oil sealer aging or damage inside gearbox	Replace them
Different abrasive wearness	Rubber aging or cracking	Replace it
	Grinding plates not on the same surface	Tighten the screws to make plates on the same surface
	Buffering spring damage	Replace it
	Wheel axle and floor surface not on the same horizontal level	Adjust the wheel axle

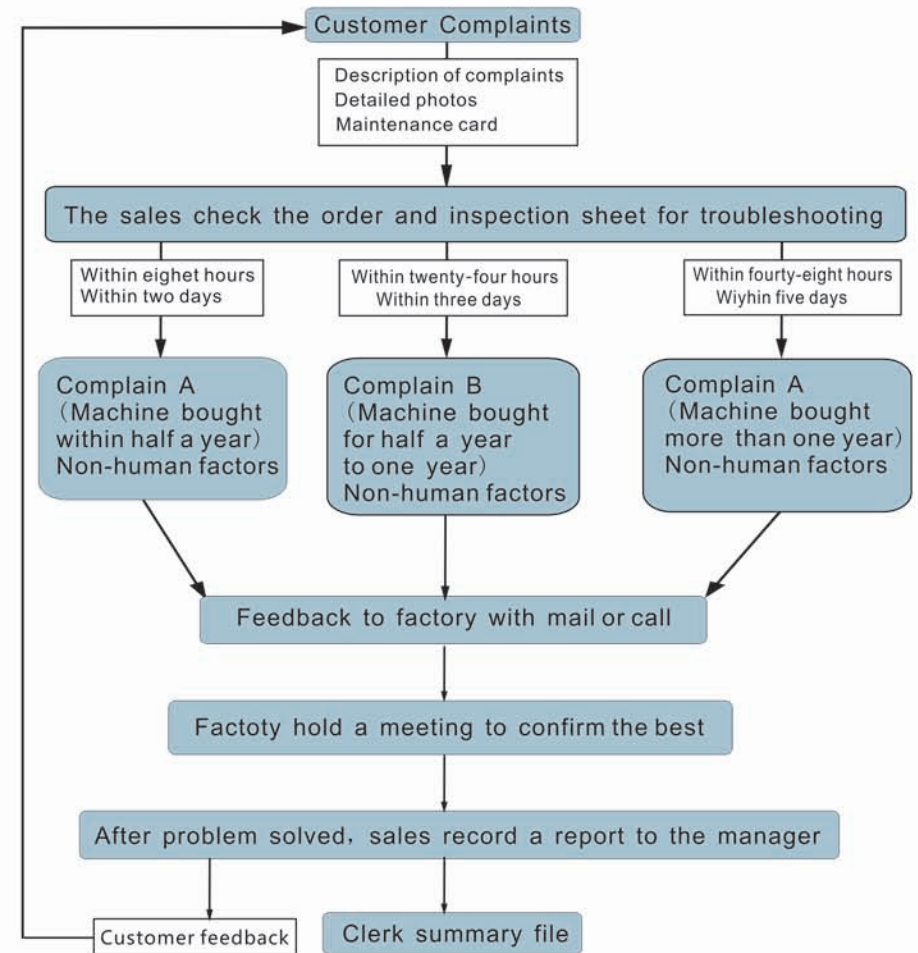

## VOCT (Voice of the customer table)

Please kindly fill in below which product model you purchased and write "√" on the proper options.

Model	Product Quality			Package Exterior			Service Quality			Products' Price		
	Poor	Normal	Excellent	Poor	Normal	Excellent	Poor	Normal	Excellent	Cheap	Normal	High
Comments and suggestions	<p style="text-align: right;">Signature : _____</p>											
Name of prepaner				Company name								
Contact telephone No				Email								

## Product Quality Inspection Certificate

Model: \_\_\_\_\_ Motor: \_\_\_\_\_

Cable: \_\_\_\_\_ Switch: \_\_\_\_\_

Shell: \_\_\_\_\_ Fittings: \_\_\_\_\_

Control: \_\_\_\_\_ Fuselage: \_\_\_\_\_

Operation: \_\_\_\_\_ Manual: \_\_\_\_\_

Packing: \_\_\_\_\_

QC by: \_\_\_\_\_ Date: \_\_\_\_\_

Our company is specialized in manufacturing floor grinding and polishing machine. All products have been inspected before leaving the factory. High tracking performance. They are also checked by the distributor with the aim of avoiding any damage occurs during transportation and the misunderstanding between the buyer and seller. Please check the operation manual before using.

Warranty under the purchase bill. Thanks for your cooperation.



7339 NW 66th Street - Miami, FL 33166  
Phone : 305-887-4133 · Fax: 305-574-0408

[nssusa.com](http://nssusa.com)

## POLISHING MACHINE

Maintenance card

Card No.:

User Name: \_\_\_\_\_ Telephone No: \_\_\_\_\_

Address: \_\_\_\_\_

Postcode: \_\_\_\_\_

Purchase Date: \_\_\_\_\_ Invoice No.: \_\_\_\_\_

Item No.: \_\_\_\_\_ Serial No.: \_\_\_\_\_

Spare Part: \_\_\_\_\_

Trouble Description:

SIGNATURE OF DEALER

1. This maintenance card can be working under affix the official seal of dealer.
  2. This maintenance card is in duplicate, both client and dealer have one.
- ★. Guarantee according to the buying bill. Thanks for cooperation